

tyler[™]
AUDIO

**THREE SPEED PORTABLE
TURNTABLE**

TTT602-BK



Operating Guide



The lightning flash and arrowhead in the triangle is a warning sign alerting you of “dangerous voltage” inside.

CAUTION

**RISK OF ELECTRIC SHOCK
DO NOT OPEN**

WARNING: To reduce the risk of electrical shock, do not open product casing. There are no user-serviceable parts inside. Refer servicing to a qualified service professional.



The exclamation point in the triangle is a warning sign alerting you of important operating instructions.

WARNING: TO REDUCE THE RISK OF FIRE OR ELECTRICAL SHOCK, DO NOT EXPOSE THIS PRODUCT TO RAIN OR MOISTURE.

This product should not be exposed to dripping or splashing. No objects filled with liquids (vases, cups, etc.) should be placed on or near this product.

CAUTION (GROUNDING OR POLARIZATION): The wider blade of the AC plug must match the slot in the “wall socket” receptacle to ensure proper electrical grounding.

CAUTION: Batteries and the battery compartment should not be exposed to excessive heat, such as sunshine or fire.

WARNING: There is a danger of explosion if batteries are incorrectly placed. Replace batteries only with the same or equivalent type.

NOTE: Under the influence of electrostatic phenomenon, this product may malfunction and cause the power to reset.

NOTE: Caution symbols are printed on the bottom of the product. Please refer to the instruction manual for more information.

LOCATION OF CONTROLS

FRONT VIEW

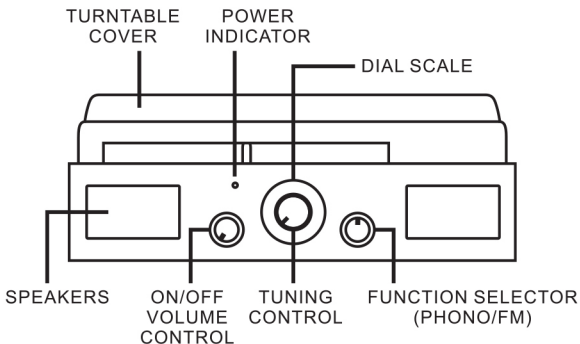

BACK VIEW

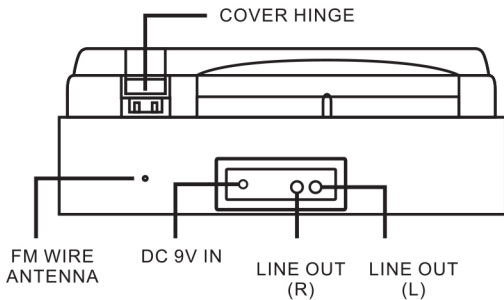

TURNTABLE VIEW

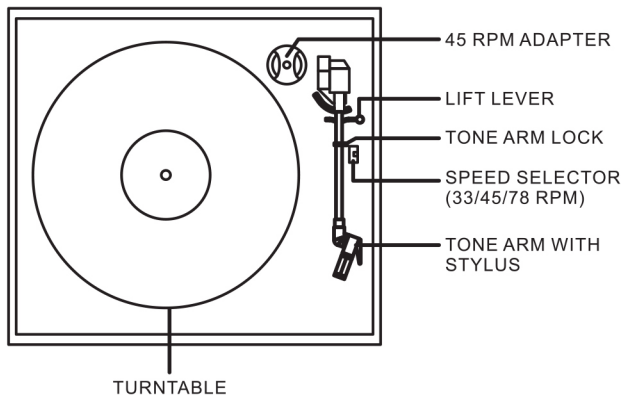

CAUTION

- TO PREVENT ELECTRIC SHOCK, MATCH WIDE BLADE OR PLUG TO WIDE SLOT. FULLY INSERT.
- DO NOT CONNECT FM WIRE ANTENNA TO EXTERNAL ANTENNA
- THIS ITEM IS NOT A TOY

POWER SUPPLY

AC OPERATION (EXTERNAL AC-DC POWER ADAPTOR)

- THIS SET IS EQUIPPED WITH A "DC-JACK" CAPABLE OF ACCEPTING AC-ADAPTORS WITH A RATING OF DC = 9V, 8A, AND WITH A PLUG WITH THE FOLLOWING POLARITIES AS SHOWN (CENTER POSITIVE) :
- PLEASE USE ONLY THE SUPPLIED AC-ADAPTOR TO OPERATE THE UNIT. USE OF OTHER ADAPTORS MAY DAMAGE THE UNIT OR CAUSE IT TO MALFUNCTION.
- PLUG THE TAIL END OF THE AC-ADAPTOR INTO THE DC 9V IN SOCKET ON THE REAR OF THE UNIT.
- INSERT THE PLUG OF THE AC-ADAPTOR INTO A WALL OUTLET WITH AC-POWER.

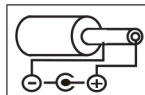

OPERATING INSTRUCTIONS

UNPACKING AND SETUP:

Carefully remove the unit from the carton and remove all packing materials from in and around the turntable cabinet. Place the turntable on a level surface, and connect the power adapter to a wall outlet. Remove the plastic stylus cover from the end of the tone arm, sliding it in the direction of the arrow [figure A]. Insert the attached record "needle" (stylus) [figure B].

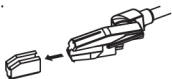

Figure A

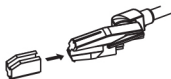

Figure B

PLAYING RECORDS:

This system includes a full-size three speed belt drive turntable that plays 33, 45 and 78RPM records.

1. To turn the unit on, press **STANDBY/ON** button and adjust the volume to a moderate level. Please be sure to install the needle and release the tone arm lock.
2. Press the **PHONO** button. The corresponding LED will light up, indicating that the unit is now in **PHONO** mode.
3. Set the turntable speed to the correct speed for the record you want to play. To play a 45RPM record, use the 45 adapter on the center spindle.
4. Move the tone arm to the record, setting the needle down at the beginning of the track you want to listen to. To stop playback, lift the tone arm and return it to the cradle. If the record plays through to the end of the side, the tone arm will return automatically and the turntable will stop spinning.

RECORDING PHONO AUDIO TO MP3 MODE:



1. Place a record on the turntable, and insert a USB Flash device into the USB slot.
2. Press the **PHONO-REC** button and start playback of the record to begin recording.
3. Press the **PHONO-REC** button again to finish recording.
4. To play back recording, press the **USB-MP3** button.

PLAYING AUDIO FROM AN AUX DEVICE:

1. Plug a 3.5mm audio cable (not included) into the **AUX-IN** jack. Connect the other end of the cable to the headphone jack of the device you want to listen from.
2. Control the volume, track select, and other features from your **AUX** device.

NOTE: **USB-MP3**, **PHONO** and **BT** function will not work with the **AUX** cable plugged in. Please remove the **AUX** cable before attempting to use any of these functions.

USB OPERATION:

Press the USB-MP3 button to turn on the USB playback mode. The USB indicator light will turn on. Insert the USB device to start playback. Use the  or  buttons to select the track you want to listen to. Press the  button to pause or resume playback.

NOTE: The USB-MP3 playback mode has a memory function. When re-inserting the same USB device, playback will resume from the last stop point automatically.

CAUTION: To avoid damage to the USB memory on your device, be sure to stop USB playback and turn off unit before removing the USB device.

LINE OUT OPERATION:

This unit features a set of line out jacks, allowing you to connect the turntable to an external speaker system. Simply plug a dual (L/R RCA cable, not included) audio plug into the line out jacks, and plug the other end into the external device input jacks.

HEADPHONE PLAYBACK:

To listen to your favorite audio through the system's headphone jack, simply plug in a set of stereo headphones (not included) to the HEADPHONE jack, located on the back of the cabinet. While the headphone jack is active, the internal speakers will be muted.

REPLACING THE STYLUS:

Lift the tone arm off the cradle. At the front end of the tone arm, place the tip of your fingernail between the red needle holder and the black cartridge housing as shown. Gently pop the red stylus off the tone arm and replace with a new one.

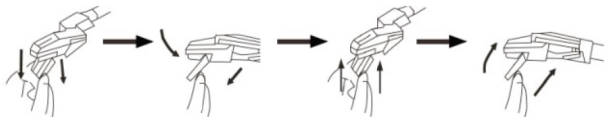

SAFETY INSTRUCTIONS

READ INSTRUCTIONS: Read all safety and operating instructions prior to use.

RETAIN INSTRUCTIONS: The safety and operating instructions should be saved for future reference

FOLLOW INSTRUCTIONS: All operating and safety instructions should be followed.

CLEANING: Unplug this product from the wall outlet before cleaning. Do not use liquid or aerosol cleaners. Use a dry cloth to clean.

WATER AND MOISTURE: To avoid electrocution risk, do not use this product near water.

STABILITY: Do not place this product on an unstable cart, stand, bracket or table. The product may fall, causing serious injury to a child or adult, and/or may damage product.

VENTILATION: Slots and openings in the cabinet are provided for ventilation and to ensure reliable operation of the product and to avoid overheating. Do not block vents.

POWER SOURCES: This product should be operated only using the type of power source indicated on the marking label. If you are not sure of the voltage of your power supply, consult your power company or product dealer. For products intended to operate using battery power, consult the operating instructions.

GROUNDING OR POLARIZATION: *If this product is equipped with a polarized alternating-current line plug (a plug having one blade that is wider than the other), the plug will only fit into the power outlet one way. This is a safety feature. If you are unable fully insert the plug into the power outlet, try reversing the plug. If this product is equipped with a three-wire grounding-type plug (a plug with a third [grounding] pin), this plug will only fit into a grounding-type outlet. If you are unable to insert the plug, contact your electrician to replace the obsolete outlet. Do not defeat the safety purpose of the polarized plug.*

POWER CORD PROTECTION: Power supply cords should be routed so that they are not likely to be walked on, tripped over, or pinched by items placed on or against them, and paying particular attention to the points where the cord meets the wall plug and where the cord leaves the product.

OVERLOAD PROTECTION: This product is equipped with an attachment plug with overload protection. This is a safety feature. See the instruction manual for replacement or resetting of protective device. If replacement of the plug is necessary, be sure that the service technician has used a replacement plug specified by the manufacturer that has the same overload protection as the original plug.

ADDED POWER PROTECTION: For added protection during a lightning storm or when product is left unused and unattended for some time, be sure to unplug product from wall outlet.

PRODUCT SERVICE: Do not attempt to service this product yourself, as opening or removing covers may expose you to dangerous voltage or other hazards. Refer all service to a qualified technician.

LIMITED WARRANTY

Tyler provides a Limited Warranty of ONE YEAR for all of its products. Tyler warrants this product to the original purchaser ONLY, to be free from defects in materials and workmanship originating from the manufacturer. Tyler agrees, at its discretion during the warranty period, to repair or replace the product if it is determined to be defective at “no charge”. This warranty does not cover cosmetic damage, antennas, AC cords, damage due to power surges, connection to improper voltage supplies, damage caused by leaking batteries, misuse, mishandling, improper application, acts of God, or attempted repair by an unauthorized service agent.

Products are sold for personal, non-commercial use only. Product is not warranted for commercial or rental use.

In order to have your merchandise repaired or replaced under warranty, you must contact Tyler's customer service department at the number or email address below **within the warranty period**. The customer service department will provide you with an RMA number (return authorization code) and the street address for product service/returns. With the product, **you must include the following**:

1. **Proof of purchase**, which must have a purchase date which falls within the warranty period specified in the product manual.
2. **All of the accessories that came in the package**, as well as the main unit.
3. **A detailed description of the problem you are having with the product.**
4. All returns must have an **RMA Number** (an RMA number can be obtained by contacting customer service).

The product must be sent in the original packaging, or a reasonable substitute, to prevent damage. You must include your full name, shipping address, and telephone number for order reference. No return will ship back to a PO Box.

REPAIR OR REPLACEMENT AS PROVIDED UNDER THIS WARRANTY IS THE EXCLUSIVE REMEDY OF THE CONSUMER. TYLER SHALL NOT BE LIABLE FOR INCIDENTAL OR CONSEQUENTIAL DAMAGES FOR BREACH OF ANY EXPRESS OR IMPLIED WARRANTY ON THIS PRODUCT.

The warranty period of a repaired or replaced unit will be the balance of the original purchase date.